

SONY®



## User's Guide

SCPH-90002

SCPH-90003

PAL



Before using this product, carefully read the supplied documentation.

## About the PlayStation®2 console documentation

The PlayStation®2 console documentation includes the following:

### • Quick Reference

A manual that is included in the package with the console. It contains information on setting up and performing basic operations on the console, as well as safety and troubleshooting information.

### • User's Guide (this document)

This document (in PDF format) is accessed from a PC through the Internet and contains information on performing advanced operations on the console, technical specifications and other information. You can download this document from the support page on the Sony Computer Entertainment Web site.

United Kingdom: [uk.playstation.com/manuals](http://uk.playstation.com/manuals)

Australia: [au.playstation.com/manuals](http://au.playstation.com/manuals)

New Zealand: [nz.playstation.com/manuals](http://nz.playstation.com/manuals)

# Table of contents

## Preparation

Getting started.....	3
Part names.....	4
Connecting to a TV.....	5
Connecting digital audio equipment.....	7
Connecting the controller.....	8
Connecting the AC power cord.....	8
Turning the console on and off.....	9

## Games

Playing a game.....	11
Using Memory Cards.....	14

## Audio CDs

Playing an audio CD.....	16
--------------------------	----

## DVDs

Watching a DVD.....	18
Using the playback modes.....	22
Adjusting DVD player settings.....	24

## Main menu

Displaying the main menu.....	31
Using the Browser screen.....	31
Using the System Configuration menu.....	32
Using the Version Information screen.....	35

## Networking

Connecting to a network.....	38
Creating network settings.....	40

## Additional information

Specifications.....	41
---------------------	----

# Getting started

## Positioning the console

You can place the console in either the horizontal or vertical position.

### Horizontal position

Set the console horizontally.



### Vertical position

When setting the console in the vertical position, use the SCPH-90110 E Vertical Stand (for PlayStation®2) (sold separately).

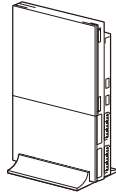

### Hint

Some Vertical Stands (for PlayStation®2) cannot be used with this model of the PlayStation®2 console. For details, see the Quick Reference manual (•▶ page 2). Choose the SCPH-90110 E when purchasing a Vertical Stand.

### Caution

Do not place the console in locations where it may be exposed to the following conditions:

- Places subject to excessive cigarette smoke or dust. Cigarette smoke residue or dust build-up on the internal components, such as the lens, may cause the console to malfunction.
- Places subject to extreme temperatures, in direct sunlight, near a heat source, or in a car with its windows closed (particularly in summer). These conditions may warp the exterior of the console or cause the console to malfunction.
- Places close to magnetic fields, such as those produced by magnets or loudspeakers.
- Places subject to vibration.

# Part names

## PlayStation®2 console front

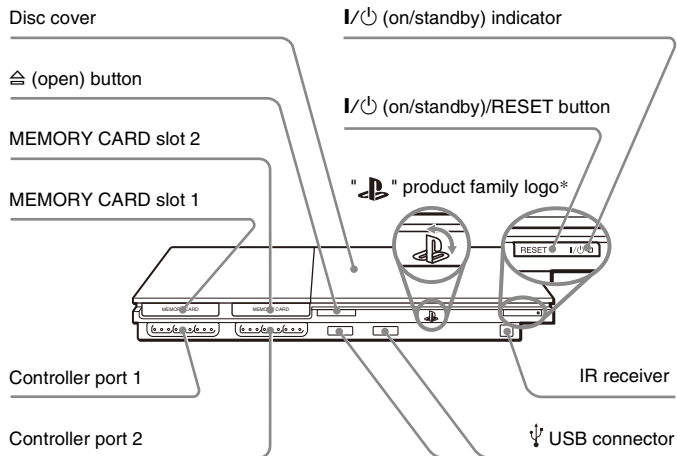

\* The "PS" product family logo can be rotated to match the horizontal or vertical positioning of the console.

### Hint

You can connect various USB devices to the PlayStation®2 console, but not all are compatible. Refer to the instructions supplied with the USB device for more information.

## PlayStation®2 console rear

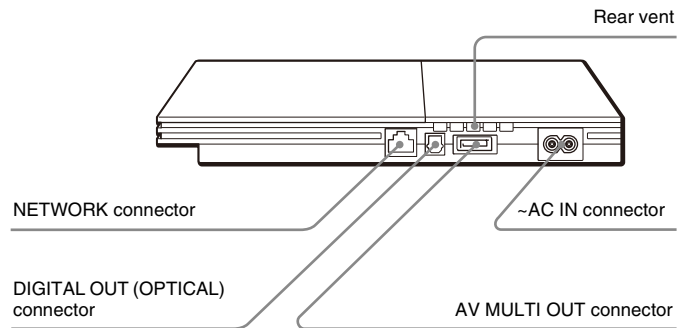

### Hint

For part names of the Analog Controller (DUALSHOCK®2), see "Using the Analog Controller (DUALSHOCK®2)" (⇨ page 13).

## Connecting to a TV

### Before connecting

- Do not plug the AC power cord for the console into the electrical outlet until you have made all other connections.
- Check that the TV is turned off.

### Connecting to a TV using the supplied AV Cable

Connect the console to the TV as shown below.

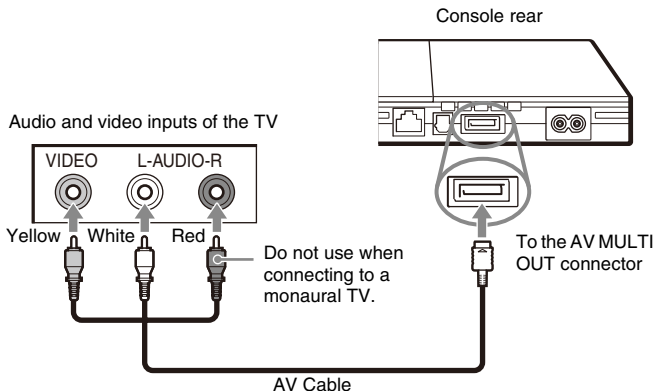

### Caution

If you display a still image on a plasma or projection\* TV screen for an extended period of time, "ghosting" may occur. This is a characteristic of these types of TVs. Static, non-moving images, such as console setting menus, DVD menus or paused images, may leave a faint image permanently on the TV screen if left on for an extended time. Refer to the instructions supplied with your TV for details.

\* Except those of LCD screen types

### Hint

The console can be connected to a VCR or an integrated TV/VCR. Note, however, that if you play a DVD with copy-protection encryption, picture quality may be reduced.

## Connecting to a TV with a Euro-AV connector using the Euro-AV connector plug (SCPH-90003)

Connect your PlayStation®2 console to the Euro-AV connector (SCART) on the TV using the Euro-AV connector plug and AV Cable, making sure you match the colour-coded plugs of the AV Cable to the matching jacks of the connector plug.

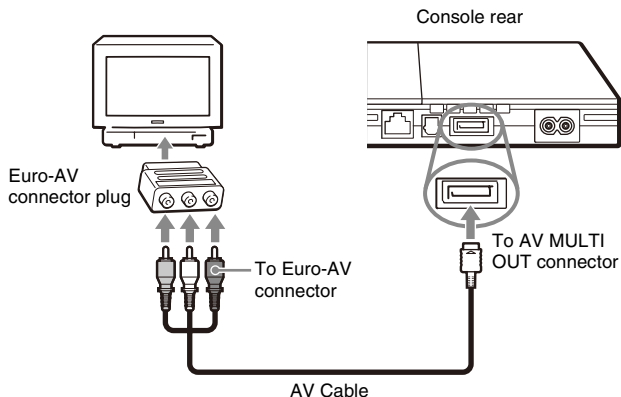

### After connecting

Set your TV to the appropriate video input mode. Refer to the Instruction Manual of your TV.

## When using a cable other than the supplied AV cable

Picture quality varies depending on the type of cable used. Use the information below to determine the best connection method.

If you use a cable other than the supplied AV cable, refer to the instructions supplied with the cable.

TV	Cable type
A TV with S VIDEO inputs	S VIDEO Cable (SCPH-10480)
A TV without video inputs	RFU Adaptor (SCPH-10072 C) (for SCPH-90002) RFU Adaptor (SCPH-10072 B) (for SCPH-90003)
A TV with Euro-AV (SCART) connector	Euro-AV Cable (SCPH-10142) (for SCPH-90003)
A TV with component video input connectors	Component AV Cable (SCPH-10490)

### Picture quality scale

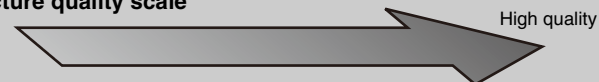

■ RFU Adaptor ■ AV Cable (supplied) ■ S VIDEO Cable ■ Component AV Cable

This scale is intended only as a reference. Depending on the product or condition of your TV, the picture quality may be different.

When using the Euro-AV Cable, picture quality may vary depending on your TV's AV connection.

For optimum picture quality, connect your Euro-AV cable to an RGB-compatible socket on your TV. Refer to the instructions supplied with your TV for details.

**Hints**

- The DVD player's progressive scan mode is only available when playing a disc recorded in NTSC format, and viewed on a TV that supports progressive scan (480p).
- You cannot connect the console to a TV with component video inputs that are exclusively for HDTV use (Y PB PR). Refer to the instructions supplied with your TV for details.

## Connecting digital audio equipment

By using a commercially available optical digital cable, you can enjoy surround sound with the effect of being in a movie theatre or a concert hall. When connecting the console to audio equipment with digital connectors, refer to the instructions supplied with the device to be connected.

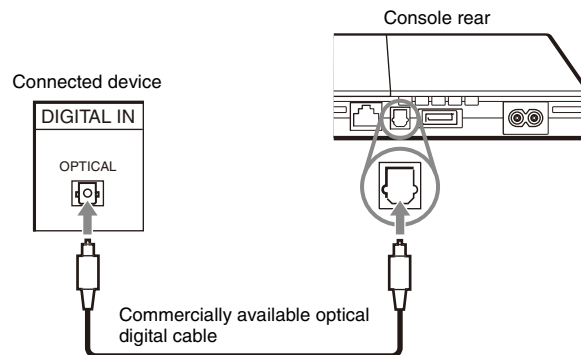
**Hints**

- If you connect the console to audio equipment using an optical digital cable, it may affect the audio output of some PlayStation®2 format software with the result that no sound is produced. If this happens, use a cable such as the supplied AV Cable and connect it to the console's AV MULTI OUT connector. Do not use an optical digital cable.
- After connecting digital audio equipment, set "Digital Out (Optical)" to "On" in the System Configuration menu. For details, see "Digital Out (Optical)" (▶▶ page 33).

## Connecting the controller

- 1 Insert the Analog Controller (DUALSHOCK®2) into a controller port of the console.

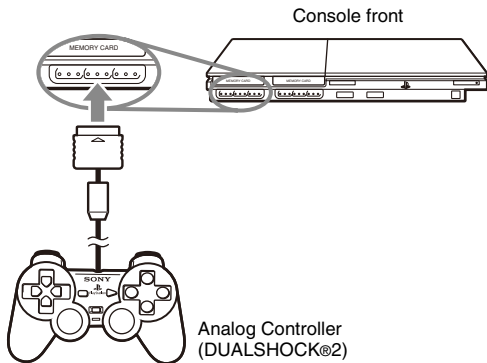

### Hint

Some software titles designate a specific controller port to be used. Refer to the instructions supplied with the software for details.

## Connecting the AC power cord

### ⚠ Warnings

- The socket-outlet shall be installed near the equipment and shall be easily accessible.
- Do not plug the AC power cord for the console into the electrical outlet until you have made all other connections.

- 1 Connect the AC power cord to the ~ AC IN connector on the console rear.

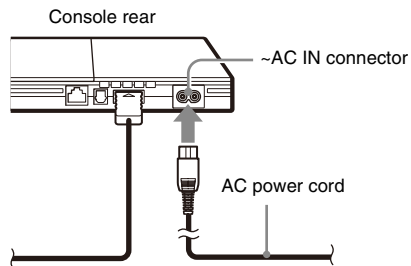



## 2 Plug the AC power cord into the electrical outlet.

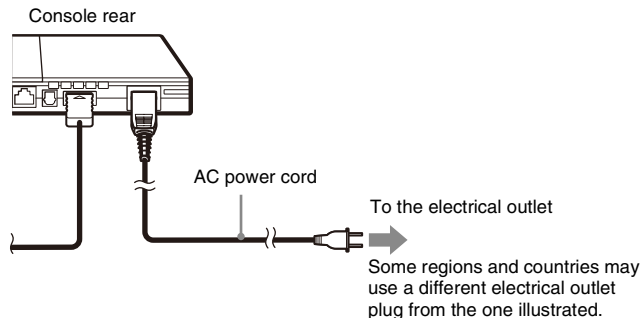

The I/⏻ (on/standby) indicator on the console front will light up in red to indicate that the console is in standby mode.

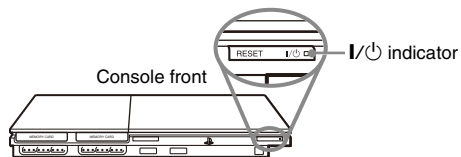

## Turning the console on and off

### Before turning on the console

Do not turn on the console until you have finished these steps. Refer to the instructions supplied with your TV for details.

- Turn on the TV.
- Change your TV setting to display output from the line to which the console is connected.

### Turning on the console

- 1 Check that the I/⏻ (on/standby) indicator on the console front is lit up in red.**
- 2 Press the I/⏻ (on/standby)/RESET button on the console front.**

The I/⏻ indicator on the console front will turn green and output from the console will be displayed on the TV.

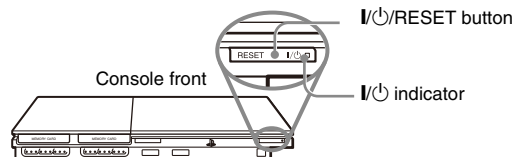

## Hints

- The first time you turn on the console after purchase, screens for setting "Language", "Time Zone" and "Daylight Savings Time (Summer Time)" will be displayed. Follow the on-screen instructions to complete the settings.
- If you connect the console to a wide-screen TV, set "Screen Size" in the System Configuration menu (\*\*► page 33).

## Turning off the console

### 1 Press and hold the I/⏻/RESET button on the console front for at least one second.

The I/⏻ indicator will turn red to indicate that the console has entered standby mode.

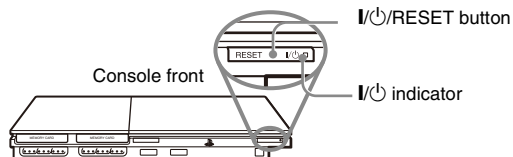

---

### ⚠ Warning

The power is not completely turned off when the console is in standby mode. If you do not plan to use the console for an extended period of time, unplug the AC power cord from the electrical outlet.

---

# Playing a game

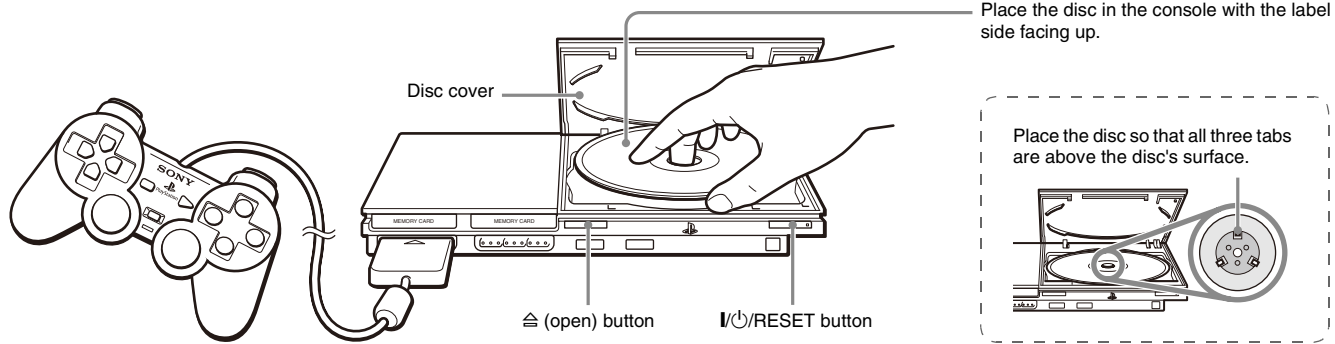

## Before playing a game

Check that the connections to the TV and audio equipment are correct and that the precautions have been met.

- "Precautions" in the Quick Reference manual (→ page 2)
- "Connecting to a TV" (→ page 5)
- "Connecting the controller" (→ page 8)
- "Connecting the AC power cord" (→ page 8)

### Hint

To play online games, you first need to connect to and set up a network. See "Connecting to a network" (→ page 38) for details.

## Starting a game

- 1 Turn on the console (→ page 9).**  
The main menu is displayed (→ page 31).
- 2 Press the ≡ (open) button on the console front.**  
The disc cover opens.
- 3 Place the disc in the console.**  
Set the disc in the disc holder with the label side facing up.

## 4 Close the disc cover.

After the disc cover is closed, the game will start.

Push the middle of the disc cover.

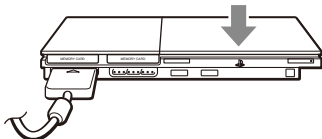

### Hints

- You can also start a game from the Browser screen (→▶ page 31).
- If you turn on the console after inserting a disc, the game will start automatically.

### To reset a game

Press the **I/⏻** (on/standby)/RESET button on the console front. Do not accidentally press the **I/⏻**/RESET button while playing a game, as doing so will cause the game to reset.

## Ending a game

### ! Caution

When removing a disc, check that the disc has stopped completely. Do not touch the disc if it is spinning, as doing so may cause injury, damage to the disc or console malfunction.

## 1 Press the **⏏** button on the console front.

## 2 Remove the disc.

Hold down the black centre part of the disc holder, and then lift the disc by the edges.

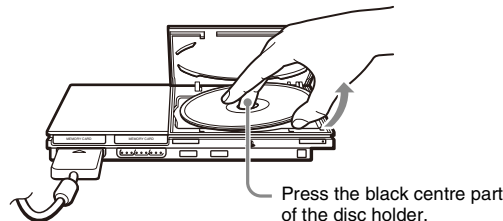

## 3 Close the disc cover.

## 4 Press the **I/⏻**/RESET button.

The main menu is displayed (→▶ page 31).

## Changing game discs

### 1 Open the disc cover and remove the disc.

When removing a disc, hold down the black centre part of the disc holder and then lift the disc by the edges.

### 2 Insert a new disc.

### 3 Close the disc cover and reset the console.

The new game will start.

### Hint

You do not need to turn off the console when changing games.

## Using the Analog Controller (DUALSHOCK®2)

The Analog Controller (DUALSHOCK®2) is equipped with a pressure-sensitive button function. It also has a vibration function.

### Part names

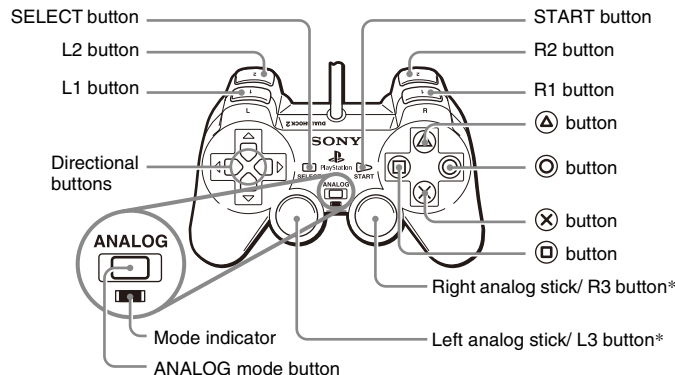

\* The left and right analog sticks, or the L3 and R3 buttons, function only in analog mode (indicator: red).

\* The L3 and R3 buttons function when the analog sticks are pressed.

### Hint

Before using the Analog Controller (DUALSHOCK®2), with the console turned on, rotate the left and right analog sticks once with your thumbs. Do not twist the analog sticks, but rotate as if drawing a circle as shown in the diagram.

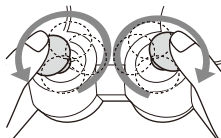

### About mode switching

The ANALOG mode button can be used to switch between two modes. Switch to the appropriate mode for use. Note, however, that some software titles make this adjustment automatically.

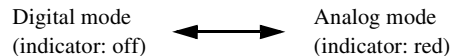

### Hints

- When using the Analog Controller in digital mode, the left and right analog sticks do not function. Also, the pressure-sensitive button function is turned off.
- Depending on the software, you may not be able to switch modes even if you press the ANALOG mode button.

### About analog controls

- When playing a PlayStation®2 format software title, you can use all buttons in analog mode except for the START, SELECT, L3 and R3 buttons.
- When playing a PlayStation® format software title, only the left and right analog sticks can be used in analog mode.

### Hint

Depending on the software, the buttons for use in analog mode may be limited. Refer to the instructions supplied with the software for details.

### About the vibration function

The vibration function can be set to ON or OFF in the software options menu.

### Hint

Depending on the software, the vibration function may be set to "On" automatically.

## About using the Analog Controller (DUALSHOCK®) (SCPH-110 E)

You can use the Analog Controller (DUALSHOCK®) (SCPH-110 E) with the PlayStation®2 console, but the functions of the buttons in analog mode may be different from those of the Analog Controller (DUALSHOCK®2). Only the left and right analog sticks can be used in analog mode.

### Hint

Not all PlayStation®2 format software titles support the use of the Analog Controller (DUALSHOCK®) (SCPH-110 E). The Analog Controller (DUALSHOCK®2) should be used in such cases.

## Using Memory Cards

You can save and load game data using a Memory Card (sold separately). You can also delete game data or copy game data from one Memory Card to another.

### About Memory Card types

There are two types of Memory Cards. Select a Memory Card suitable for the software in use.

Memory Card type	Compatible software	Amount of memory
Memory Card (8MB) (for PlayStation®2) (SCPH-10020 E)	PlayStation®2 format software	Approx. 8 MB
Memory Card (SCPH-1020 E)* * This product is no longer manufactured.	PlayStation® format software	15 memory blocks (approx. 120 KB)

MagicGate™ is a term of copyright protection technology developed by Sony Corporation.

## Inserting a Memory Card

Insert the Memory Card into a MEMORY CARD slot on the console front.

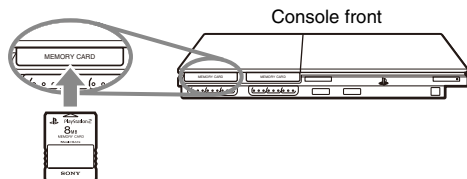

### Hint

Some software titles designate a specific MEMORY CARD slot to use. Refer to the instructions supplied with the software for details.

## Saving or loading game data

Depending on the software, the procedure for saving or loading may vary. Refer to the instructions supplied with the software for details.

## Copying or deleting game data

- 1 At the Browser screen (→ page 31), use the directional buttons to select the icon for the Memory Card you want to use for copying or deleting data and then press the (X) button.**
- 2 Select the icon for the data you want to copy or delete, and then press the (X) button.**

- 3 Select "Copy" or "Delete", and then press the (X) button.**

When copying game data, check that two Memory Cards are inserted in the console. If you have selected "Delete", skip to step 5.

- 4 Select the destination, and then press the (X) button.**

- 5 Select "Yes", and then press the (X) button.**

While copying or deleting data, do not remove the Memory Cards.

- 6 When copying or deleting is completed, press the (O) button.**

### Hints

- To view information about a game data item, select the icon for the data and then press the (A) button to check the details.
- Compatibility between software and Memory Cards:
  - You cannot save or copy PlayStation®2 format software to a Memory Card (SCPH-1020 E).
  - You cannot save PlayStation® format game data to a Memory Card (8MB) (for PlayStation®2). You can, however, copy PlayStation® format game data from a Memory Card (SCPH-1020 E) to a Memory Card (8MB) (for PlayStation®2) for storage purposes. Note that such game data cannot be loaded directly from a Memory Card (8MB) (for PlayStation®2).

## Playing an audio CD

### Playing a CD

#### 1 Turn on the console and insert the disc (→ page 11).

Follow steps 1 to 4 of "Starting a game".

The track numbers are displayed.

#### 2 Using the directional buttons, select the track number you want to play and then press the (X) button.

Playback begins.

#### Hints

- If you turn on the console after inserting a disc, the track numbers are displayed automatically.
- You can also start playback from the Browser screen (→ page 31).

#### ! Caution

To play an audio CD recorded in DTS format, you must connect a device with a DTS decoder to the DIGITAL OUT (OPTICAL) connector (→ page 7). Note that an extremely loud noise may be emitted if the device does not have a DTS decoder or if it is connected to the AV MULTI OUT connector.

## Operating the CD player during playback

Using the directional buttons, select the icon for the desired track and then press the (X) button.

Icon (button*)	Function
⏮ (L1 button)	Go to the beginning of the current or previous track
⏪ (L2 button)	Fast reverse
⏩ (R2 button)	Fast forward
⏭ (R1 button)	Go to the beginning of the next track
▶ (START button)	Start playback
⏸ (START button)	Pause playback
■ (SELECT button)	Stop playback

\* You can operate directly by pressing the analog controller (DUALSHOCK®2) buttons shown in parentheses.

#### Hint

You can also use the DVD Remote Control (for PlayStation®2) (sold separately).

## Ending audio CD playback

#### 1 Using the directional buttons, select ■ and then press the (X) button.

Playback stops. Press the ⏏ (open) button on the console front to remove the disc.



## Playing in various modes

You can set for "Play Mode" and "Repeat".

Play Mode	Normal	Plays tracks as recorded on the CD
	Program	Plays tracks in a specified order
	Shuffle	Plays tracks in a random order
Repeat	Off	Does not play the CD repeatedly
	All	Plays all tracks repeatedly
	1	Plays a track repeatedly

### 1 At the Browser screen (→ page 31), use the directional buttons to select the audio CD icon and then press the $\Delta$ button.

The Play Options screen is displayed.

### 2 Select "Play Mode" or "Repeat", and then press the $\otimes$ button.

### 3 Select the desired setting, and then press the $\otimes$ button.

If you select "Program", the screen for specifying track order will be displayed. Select the tracks you want to play.

### 4 Press the $\odot$ button.

The Browser screen is displayed.

### 5 Select the audio CD icon, and then press the $\otimes$ button.

The track numbers are displayed, and the setting option is shown in the lower left of the screen.

### 6 Select the desired track, and then press the $\otimes$ button.

Playback begins.

#### Hints

- You can also access the Play Options screen from the screen displaying the tracks by selecting the Audio CD icon in the upper left corner of the screen and pressing the  $\Delta$  button.
- You can set "Play Mode" and "Repeat" at the same time.

## Watching a DVD

You can operate the DVD player using the following methods.

- Using the on-screen Control Panel
- Operating directly using the Analog Controller (DUALSHOCK®2)
- Using the DVD Remote Control (for PlayStation®2) (sold separately)

The following instructions assume use of the Control Panel to operate the DVD player. Some operations may be different depending on the method used.

### Hints

- For details about playing a DVD, refer to the instructions supplied with the DVD.
- The PlayStation®2 console plays disc content as recorded in the DVD software.  
Note that not all features are available on all DVDs.

## Using the Control Panel

**1 Start playback of the DVD (→ page 20).**

**2 Press the SELECT button.**

The Control Panel is displayed. If you press the SELECT button again, the display will change its position on the screen.



**3 Using the directional buttons, select an icon and then press the (X) button.**













### Hint









To turn off the Control Panel, press the SELECT button (once or twice), or press the (O) button.

### Control Panel item list

You can access the following options in the Control Panel.

Icon		Function
	Menu	Displays the DVD-Video menu
	Top Menu	Displays the DVD-Video menu

Icon	Function
	Return Returns to the previously selected screen within the DVD's menu
	Audio Options Displays and changes audio options on DVDs with multiple audio tracks
	Angle Options Displays and changes viewing angles on DVDs recorded with multi-angle options
	Subtitle Options Displays and changes subtitle options on DVDs with subtitle options
	Go To Skips to the selected title, chapter or the specified time, and starts playback (**▶ page 20)
	Setup Displays and changes options for language, picture quality, Parental Control level, audio, etc. (**▶ page 24)
	Time Display Displays the current title or chapter number, the elapsed time, etc. (**▶ page 21)
	Help Displays the direct button functions of the Analog Controller (DUALSHOCK®2)
	Go to Chapter Used to enter the number of a chapter you want to play (**▶ page 20)
	Previous/Next Returns/skips to the beginning of the current, previous or next chapter
	Search Fast reverses/forwards playback
	Slow Changes to playback/reverse playback in slow-motion

Icon	Function
	Play Starts playback
	Pause Pauses playback
	Stop Stops playback (**▶ page 20)
	A-B Repeat Specifies a scene for playback, and starts playback of the scene that has been set (**▶ page 23)
	Shuffle Play Begins playback of titles or chapters in a random order (**▶ page 23)
	Program Play Begins playback of titles or chapters in a programmed sequence (**▶ page 22)
	Repeat Play Selects repeated playback of all the titles on the disc, or one title or one chapter (**▶ page 23)
	Original/Play List For DVD-RW discs (VR mode), selects Original or Play List content to play (**▶ page 22)
	Clear Clears selected numbers or playback modes (**▶ page 24)

### Hints

- You can use "?" to check the options that can be accessed directly using the buttons of the Analog Controller. To access the options directly using the controller, you must clear the Control Panel from the screen.
- Depending on the playback mode, some options may not be available or cannot be adjusted.

## Playing a DVD

### 1 Turn on the console and insert a disc (→ page 11).

Follow steps 1 to 4 of "Starting a game". Playback begins.

#### Hints

- If you turn on the console after inserting a disc, playback will begin automatically.
- You can also start playback from the Browser screen (→ page 31).

## Ending DVD playback ■

### 1 During playback, select ■ in the Control Panel (→ page 18) and then press the ⊗ button.

Playback stops. Press the ⏏ (open) button on the console front, and then remove the disc.

## Playing a DVD from the last stopping point (Resume Play)

### 1 During playback, select ■ in the Control Panel (→ page 18) and then press the ⊗ button.

### 2 Select ►, and then press the ⊗ button.

Playback begins from the point where you stopped the disc in step 1.

#### To clear Resume Play

After step 1, select ■ and then press the ⊗ button.

## Selecting a specific scene for playback

### Selecting a scene by chapter number

#### 1 During playback, select the desired chapter number in the Control Panel (→ page 18) and then press the ⊗ button.

Playback of the selected chapter begins. If you want to play a chapter with a single digit number (i.e. 1-9), enter a leading zero. For example, enter as "01".

### Selecting a scene by title number, chapter number or by specifying the time

#### 1 During playback, select ↻ in the Control Panel (→ page 18) and then press the ⊗ button.

#### 2 Select an item, and then press the ⊗ button.

Title	Specifies the title number
Chapter	Specifies the chapter number
C XX:XX:XX (or T XX:XX:XX)	Specifies the elapsed time for the chapter (or title)

#### 3 Select the numbers for the desired scene, and then press the ⊗ button.

Playback of the selected chapter begins.

## Finding a particular point on a DVD (Search)



You can search either forwards or backwards to quickly locate a particular point on a DVD.

### 1 During playback, select or in the Control Panel (→ page 18) and then press and hold the button.

Search speed changes as shown below when you press either the up or down directional button while holding down the button.

- Search 3
- Search 2
- Search 1
- Slow

### 2 Release the button when you reach the point you are searching for.

Playback returns to normal speed.

#### Hint

To use the Analog Controller to Search during playback, press and hold down the L2 or R2 button to begin searching. Use the directional buttons to change speeds. Release the L2 or R2 button when you reach the point you are searching for.

## Displaying playback information

You can display information such as the current title number or elapsed time.

### 1 During playback, select in the Control Panel (→ page 18) and then press the button.

The display changes as shown below each time you press the button.

Title X	Chapter X		Title number and chapter number
Title X	Chapter X	C XX:XX:XX	Elapsed time of current chapter
Title X	Chapter X	C - XX:XX:XX	Remaining time of current chapter
Title X	Chapter X	T XX:XX:XX	Elapsed time of current title
Title X	Chapter X	T - XX:XX:XX	Remaining time of current title
(Off)			

## Selecting Original or Play List for DVD-RW playback **P LIST**

When using a DVD-RW disc (VR mode), you can select the type of titles you want to play.

### 1 With playback stopped, select **P LIST** in the Control Panel (→ page 18) and then press the **X** button.

Original and Play List will be selected in turn each time you press the **X** button.

Original	Plays content in the originally recorded sequence
Play List	Plays edited content. Play List is the default setting.

#### Hints

- Slow-motion play in reverse is not available for DVD-RW discs (VR mode).
- You cannot use this function with Resume Play. Clear Resume Play (→ page 20) before selecting this feature.

## Using the playback modes

Using the various playback modes, you can play titles or chapters in the order you want or repeat playback of a specific scene. There are four playback modes:

- Program Play (→ page 22)
- Shuffle Play (→ page 23)
- Repeat Play (→ page 23)
- A-B Repeat (→ page 23)

The following instructions assume use of the Control Panel (→ page 18) to operate the DVD player.

#### Hints

- You can play combinations of Program Play, Shuffle Play, and Repeat Play. Note, however, that some Shuffle Play or Repeat Play options may not be available depending on the combination.
- The PlayStation®2 console plays disc content as recorded in the DVD software.

## Program Play **PGM**

You can create programmes to play titles and chapters in any order.

### 1 During playback, select **PGM** in the Control Panel (→ page 18) and then press the **X** button.

### 2 Select a programme number, and then press the **X** button. If no programmes have been set, the only option will be "1. Title".

### 3 Select the title number, and then press the **X** button.

**4 Select the chapter number, and then press the (X) button.**

To play all the chapters, select "All". Repeat steps 2 to 4 to set other titles or chapters.

**5 Press the START button.**

Program Play begins.

**Hint**

The setting will not be cleared after Program Play finishes.

**Shuffle Play SHUF**

You can set this option for random playback of all titles or chapters recorded on a disc. Playback order will be different each time Shuffle Play is used.

**1 Select SHUF in the Control Panel (→ page 18), and then press the (X) button.**

The display changes as shown below each time you press the (X) button.

Title Shuffle	Plays titles in random order
Chapter Shuffle	Plays chapters in random order
Shuffle Off	Clears Shuffle Play

**2 Select ►, and then press the (X) button.****Repeat Play** 

You can set this option to play titles or chapters repeatedly.

**1 Select  in the Control Panel (→ page 18), and then press the (X) button.**

The display changes as shown below each time you press the (X) button.

Disc Repeat	Repeats playback of all titles
Title Repeat	Repeats playback of one title
Chapter Repeat	Repeats playback of one chapter
Repeat Off	Clears Repeat Play

**2 Select ►, and then press the (X) button.****A-B Repeat A-B**

You can set a specific scene to be played repeatedly.

**1 During playback, select A-B in the Control Panel (→ page 18) and then press the (X) button at the point you want to start repeated playback.**

The starting point (point A) is set.

**2 Press the (X) button at the point you want to end repeated playback.**

The ending point (point B) is set, and repeated playback of the section from A to B begins.

## Clearing playback modes **CLEAR**

Clears playback modes to allow normal playback.

- 1 Select **CLEAR** in the Control Panel (→ page 18), and then press the **X** button.**

A message stating, "Play mode contents cleared", is displayed and the console returns to normal playback.

### Hint

If multiple playback modes have been set in a combination, all playback modes are cleared.

## Adjusting DVD player settings

You can use the Control Panel to adjust DVD player settings, such as the language for subtitles, audio language, and Parental Control level.

### Hints

- Some DVDs do not support all settings. The PlayStation®2 console plays disc content as recorded in the DVD software. If the DVD does not support the features listed, you will not be able to change the settings.
- The following options are not available during playback or Resume Play. Clear Resume Play (→ page 20) before changing these settings.
  - "Menu", "Audio" and "Subtitles" in Language Setup
  - "TV Type" and "Progressive" in Screen Setup
  - "Parental Control" in Custom Setup
  - "DTS" and "Audio Track Auto Select Mode" in Audio Setup

You can change DVD player settings using the following procedure:

- 1 Select  in the Control Panel (→ page 18), and then press the **X** button.**

The Setup icon bar is displayed.

- 2 Select the icon for the setting you want to change, and then press the **X** button.**

The current setting for each item is displayed.

- 3 Select the desired item, and then press the **X** button.**

The menu option becomes active and can be selected.



#### 4 Select the desired setting, and then press the **(X)** button.

The setting of the item is completed. For details, see the instructions for each item (→ pages 25 to 30).

##### Hints

- The default setting for each menu item is underlined in the explanations below.
- To return to the Control Panel after making settings, press the SELECT button.
- Settings are saved when you do any of the following:
  - Stop playback (including stopping Resume Play)
  - Open the disc cover

### Setting language options

In "Language Setup" you can choose the language for the DVD's menu, audio and subtitles. Note that if you select a language that is not recorded on the DVD, one of the recorded languages is selected automatically.

Menu	Selects the language for the DVD's menu
Audio	Selects the language for the DVD's audio track
Subtitles	Selects the language for the DVD's subtitles

##### Hint



If you select "Audio Follow" for subtitles, the subtitle language will automatically be set to match the language selected for the DVD's audio track.

### Setting TV display options

In the Screen Setup menu, you can set the screen size (aspect ratio) and other options that affect picture quality.

#### TV Type

You can set the aspect ratio to match the screen of the connected TV.

<u>16:9</u> 	Select this option when using a widescreen TV or a standard TV with special 16:9/widescreen functionality.
4:3 Letter Box 	Select this option when using a standard TV. This setting displays a wide picture with margins on the upper and lower portions of the screen.
4:3 PAN SCAN 	Select this option when using a standard TV. This setting displays a picture adjusted to the height of the screen, cutting off portions at left and right that do not fit.

##### Hint

When you set "Progressive" to "On", "TV Type" is automatically set to "16:9".

## DNR (Digital Noise Reduction)

You can use this setting to help reduce roughness in the on-screen image and produce a cleaner picture.

<u>Off</u>	DNR is not used.
DNR1	Increases picture quality
DNR2	Increases picture quality (maximum)

### Hints

- "DNR2" is more effective for reducing image roughness than "DNR1", but in some cases an afterimage may appear. If this occurs, select "Off".
- The DNR function may produce limited results on some DVDs.
- When you set "Progressive" to "On", "DNR" is automatically turned off and cannot be turned on.

## Outline Sharpening

You can sharpen or soften the outline of the on-screen image. The higher the value, the sharper the outline. Normally, select "0".

• -2	• -1	<u>• 0</u>	• +1	• +2
------	------	------------	------	------

### Hint

Depending on the DVD, Outline Sharpening may produce limited results.

## Display

During playback, you can display playback status information in the top right corner of the screen for a few seconds.

<u>On</u>	Playback status information is displayed for a few seconds.
Off	Playback status information is not displayed.

## Progressive

You can display an image in which the picture updates all the lines in one pass. In most cases, this results in a clearer, flicker-free image. This feature is available only if your TV and AV Cable\* support progressive scan (480p).

\* The Component AV Cable (sold separately) is compatible with progressive scan.

<u>On</u>	Select this option when the console is connected to a TV that supports progressive scan (480p).*
Off	Select this option when the console is connected to a standard TV.

\* The DVD player's progressive scan mode is only available when playing a disc recorded in NTSC format, and viewed on a TV that supports progressive scan (480p).

### Hints

- If picture quality is reduced or no image is displayed, set "Progressive" to "Off" when the console is connected to a TV without the necessary equipment. If you accidentally set this option to "On" for such a TV, picture quality may be reduced or the picture may not be displayed. To clear the setting, follow these steps:

**1** Check that you have a DVD in the console.

**2** Press the **I/⏻** (on/standby)/RESET button on the console front.

Then press and hold down the START button of the Analog Controller (DUALSHOCK®2) in controller port 1 until the DVD picture is displayed. The "Progressive" setting is returned to "Off", allowing the DVD-Video to be displayed as normal. You can also cancel this setting using the "Clear Progressive Setting" (⇨ page 36) option in the Version Information screen.

- DVDs can contain video-based and film-based material, which use different frame rates. When playing video-based material using progressive scan, some images may appear unnatural. If this occurs, set "Progressive" to "Off" and view in standard interlace mode.
- When you set "Progressive" to "On", "TV Type" (⇨ page 25) is automatically set to "16:9".

- DVD-RW disc (VR mode) content can only be viewed in standard interlace format. The "Progressive" option is not available when playing such content.

## Setting viewer options

### Pause mode

You can use this option to set a picture status when playback is paused.

Auto	A picture with moving elements is displayed without jitter. Normally select this position.
Frame	A picture without moving elements can be displayed at high resolution.

### Parental Control

In some regions, the viewing of some DVD content may be restricted based on viewer age or other factors. You can use the Parental Control feature to restrict the level of content that may be viewed through your console.

The lower the value, the stricter the restriction.

### Setting Parental Control

#### 1 Select "Parental Control", and then press the **⊗** button.

The screen for registering a password is displayed. If a password has already been registered, the screen for confirming the password is displayed.

#### 2 Select a number, and then press the **⊗** button.

Repeat step 2 to enter a four-digit password. If you want to clear a number, press the **⊙** button. When registering a password, you are required to enter it again for confirmation.

#### 3 Select "Region", and then press the **⊗** button.

The list of region options is displayed.

#### 4 Select the region to base the Parental Control level on, and then press the **⊗** button.

If you select "Other", see "Region code list" (→ page 28).

#### 5 Select "Level", and then press the **⊗** button.

The list of level options is displayed.

#### 6 Select a restriction level, and then press the **⊗** button.

#### To clear Parental Control

With DVD playback stopped, go to step 6 in "Setting Parental Control" and set "Level" to "Off".

## Region code list

To enter a Parental Control region code, select "Other" in step 4 of "Setting Parental Control" (→▶ page 27). Use the directional buttons to select the first letter, and then press the right directional button. Then select the next letter and press the (X) button.

Region	Code	Region	Code
Austria	AT	Malaysia	MY
Belgium	BE	Netherlands	NL
Canada	CA	Norway	NO
China	CN	Philippines	PH
Denmark	DK	Russia	RU
Finland	FI	Singapore	SG
France	FR	Spain	ES
Germany	DE	Sweden	SE
Hong Kong	HK	Switzerland	CH
Indonesia	ID	Taiwan	TW
Italy	IT	Thailand	TH
Japan	JP	United Kingdom	GB
Korea	KR		

## Changing your password

In step 2 of "Setting Parental Control" (→▶ page 27), complete the following steps:

### 1 Using the directional buttons, select "Change Password" and then press the (X) button.

The screen for changing the password is displayed.

### 2 Select a number, and then press the (X) button.

Repeat step 2 to enter a four-digit password. You are required to enter it again for confirmation.

## Temporary override of Parental Control restrictions

### 1 Start playback of the DVD (→▶ page 20).

You will be prompted to temporarily change the Parental Control level to allow playback. This usually occurs immediately at disc start-up but may also occur at different times depending on the DVD.

### 2 Using the directional buttons, select "Yes" and then press the (X) button.

The screen for entering the password is displayed.

### 3 Select a number, and then press the (X) button.

Repeat step 3 to enter the four-digit password. After entering the password, playback will begin again. When DVD playback is stopped, the Parental Control level returns to the original setting.

## Hints

- If you forget your password, see the Quick Reference manual (→▶ page 2).
- If you do not set a password, you cannot change the Parental Control settings.
- Some DVDs with the Parental Control feature do not allow use of playback modes (→▶ pages 22 to 23).

## Setting sound options

### Audio Digital Out

You can switch the method of outputting the audio signal when you connect the following audio devices to the DIGITAL OUT (OPTICAL) connector.

#### Caution

When the console is connected to an audio device without a Dolby Digital, DTS or MPEG decoder, set "Dolby Digital", "DTS" and "MPEG" to "Off". If you set these options to "On" without the necessary decoder, you may have no sound or an extremely loud noise may be emitted.

### Digital Out (Optical)

This option sets the type of output for the DIGITAL OUT (OPTICAL) connector.

<u>On</u>	Select this option when you want sound (audio signal) to be output through the DIGITAL OUT (OPTICAL) connector. Settings for "Dolby Digital", "DTS" and "MPEG" are displayed.
Off	Select this option when you do not want sound to be output through the DIGITAL OUT (OPTICAL) connector. Settings for "Dolby Digital", "DTS" and "MPEG" are not displayed.

### Dolby Digital

This option sets Dolby Digital as the output signal for the DIGITAL OUT (OPTICAL) connector.

<u>On</u>	Select this option when the console is connected to an audio device with a built-in Dolby Digital decoder.
Off	Select this option when the console is connected to an audio device without a built-in Dolby Digital decoder.

### DTS

This option sets DTS as the output signal for the DIGITAL OUT (OPTICAL) connector.

<u>On</u>	Select this option when the console is connected to an audio device with a built-in DTS decoder.
Off	Select this option when the console is connected to an audio device without a built-in DTS decoder.

### MPEG

This option sets MPEG AUDIO as the output signal for the DIGITAL OUT (OPTICAL) connector.

<u>On</u>	Select this option when the console is connected to an audio device with a built-in MPEG decoder.
Off	Select this option when the console is connected to an audio device without a built-in MPEG decoder.

## Audio Track Auto Select Mode

This setting gives priority to the audio track that contains the highest number of channels when you play a DVD on which multiple audio formats (PCM, Dolby Digital, DTS or MPEG) are recorded. If PCM, Dolby Digital, DTS and MPEG have the same number of channels, the console selects PCM, Dolby Digital, DTS and MPEG audio tracks in that order.

On	Priority given
<u>Off</u>	No priority given

### Hints

- If you set "DTS" to "Off" in "Audio Digital Out" (⇨ page 29), the DTS audio track is not played.
- Depending on the DVD, the audio channel with priority may be predetermined. In this case, the audio track will be selected based on the DVD's order of priority.

## DVD Volume

You can set this option if the audio output level of the DVD is low. You can set this only when "Digital Out (Optical)" is set to "Off" in "Audio Digital Out" (⇨ page 29).

+2	Turns up the volume (maximum)
+1	Turns up the volume
<u>Standard</u>	Normally select this option.

---

---

### Caution

If you set this option to "+1" or "+2", the sound may become distorted. If this happens, change the setting to "Standard". Also note that if you set the volume too high, it may harm your hearing or damage the speakers.

---

## Displaying the main menu

From the main menu, you can access information and change various settings. You can also move to the following screens from the main menu. The main menu is displayed when you turn on the console without a disc inserted.



- Browser screen (→▶ page 31)
- System Configuration menu (→▶ page 32)
- Version Information screen (→▶ page 35)

### 1 Turn on the console (→▶ page 9).

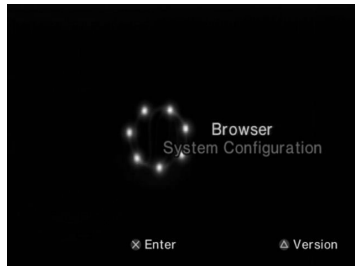
The main menu is displayed. Note that it may take some time for the main menu to be displayed.



#### Hint

If you turn on the console with a disc inserted, the main menu will not be displayed. To display the main menu, press the  (open) button on the console front and remove the disc. Then press the  (on/standby)/RESET button to reset the console.

## Using the Browser screen

You can do the following from the Browser screen:

- Copy or delete game data saved on a Memory Card
- Start a game
- Start playback of an audio CD
- Start playback of a DVD

### 1 Display the main menu (→▶ page 31).

### 2 Using the directional buttons, select "Browser" and then press the button.

The Browser screen is displayed.

### 3 Insert a disc or Memory Card.

the inserted item is displayed on the Browser screen.

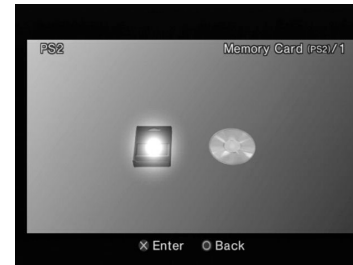

## 4 Select an icon, and then press the (X) button.

- When you select the Memory Card icon, icons for data saved on the Memory Card are displayed. To copy or delete saved game data, see "Copying or deleting game data" (→ page 15).
- If you select the icon for a PlayStation®2 or PlayStation® format software disc, the game will start.
- When you select the icon for an audio CD, the tracks contained on the CD are displayed. See "Playing an audio CD" (→ page 16).
- If you select the icon for a DVD, playback of the DVD will begin.

### Hint

The message "There is no data" is displayed on the Browser screen when no Memory Card or disc is inserted in the console.

## Using the System Configuration menu

From the System Configuration menu, you can change settings for numerous options including language or time display, and audio or video output method.

### 1 Display the main menu (→ page 31).

### 2 Using the directional buttons, select "System Configuration" and then press the (X) button.

The System Configuration menu is displayed.



### 3 Select an item, and then press the (X) button.

The menu option becomes active and can be selected.

### 4 Select the desired setting, and then press the (X) button.

For details, see the instructions for each menu item (→ pages 33 to 34).



## Hints

- The default setting for each menu item is underlined in the explanations below.
- Changes to each setting are saved and remain in effect even after you turn off or reset the console.

## Clock Adjustment

You can set the date and time. Use the directional buttons to set "Year", "Month", "Day", "Hour", "Minute" and "Second". The setting goes into effect when you press the **(X)** button.

### Optional settings

If you press the **(Δ)** button at the "Clock Adjustment" screen, you can set options such as "Date Format" or "Time Format". Use the directional buttons and the **(X)** button to make each setting.

Time Format	Sets the system clock to either 12-hour or 24-hour clock display
Date Format	Sets the display order of year, month and day
Time Zone	Sets the time zone
Daylight Savings Time	Sets Standard or Daylight Savings (Summer Time). Normally select "Standard".

## Screen Size

You can set the display mode for the TV.

<u>4:3</u>	Select this option when using a standard TV with the console.
Full*	Select this option when using a standard TV with the console. The black margins on the upper and lower portions of the screen are cut off.
16:9	Select this option when using a wide-screen TV or a standard TV with special 16:9/wide-screen functionality.

\* "Full" display mode is compatible with the System Configuration menu, Browser screen and audio CD screen.

## Digital Out (Optical)

You can set whether to output the signal through the DIGITAL OUT (OPTICAL) connector.

<u>On</u>	Select this option when you want to output signal through the DIGITAL OUT (OPTICAL) connector.
Off	Select this option when you do not want to output signal through the DIGITAL OUT (OPTICAL) connector.

## Component Video Out

When using the Component AV Cable (sold separately), you must set the mode to match the input jacks on your TV.

Y Cb/Pb Cr/Pr	Select this option when connecting the console to component video input connectors (default setting for SCPH-90002).
RGB	Select this option when connecting the console to RGB input connectors (default setting for SCPH-90003).

### Hint

The "RGB" setting is only for PlayStation®2 and PlayStation® format software. When you watch a DVD, the mode automatically switches to "Y Cb/Pb Cr/Pr".

## Remote Control

You can set this option when using the DVD Remote Control (for PlayStation®2) (sold separately).

<u>Gameplay Function On</u>	Select this option when operating PlayStation®2 or PlayStation® format software with the DVD Remote Control.
Gameplay Function Off	Select this option when not operating PlayStation®2 or PlayStation® format software with the DVD Remote Control.

### Hint

The following limitations apply when the DVD Remote Control is set to "Gameplay Function On":

- Depending on the software, some remote control buttons may not work properly.
- The buttons of the DVD Remote Control will not work when two or more buttons are pressed at the same time.
- Some software titles may stop operating properly when a controller is removed from controller port 1. If this happens, set to "Gameplay Function Off".

## Language

You can use this option to select the language displayed on the main menu, Browser screen, System Configuration menu, and Version Information screen.

<u>English</u>	Displays messages in English
French	Displays messages in French
Spanish	Displays messages in Spanish
German	Displays messages in German
Italian	Displays messages in Italian
Dutch	Displays messages in Dutch
Portuguese	Displays messages in Portuguese

# Using the Version Information screen

You can check version information for various console components by selecting this option. You can also change optional settings for some items.

## 1 At the main menu (→ page 31), press the **△** button.

The Version Information screen is displayed.

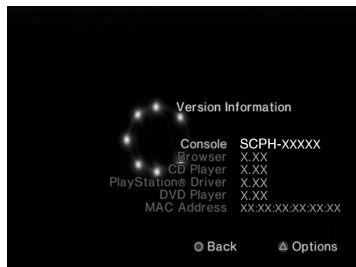

## Optional settings

Optional settings are available for "Console", "PlayStation® Driver" and "DVD Player". "DVD Player" can be set only if the DVD player's "Progressive" option is set to "On".

## 1 Using the directional buttons, select an item and then press the **△** button.

The current setting for the item is displayed.

## 2 Select an item, and then press the **⊗** button.

The available options are displayed.

## 3 Select the desired setting, and then press the **⊗** button.

For details, see the instructions for each item (→ pages 35 to 37).

### Hint

The default setting for each menu item is underlined in the explanations below.

## Console

The PlayStation®2 console automatically adjusts its internal settings for optimal playback. When "Diagnosis" is set to "On", the console makes additional adjustments.

## Diagnosis

<u>Off</u>	Diagnosis is turned off.
On	Diagnosis is turned on.

### Hint

The "Diagnosis" setting will automatically return to the default setting in the following cases:

- When playback of PlayStation®2 or PlayStation® format software or a DVD begins
- When the console is reset
- When the console is turned off

## PlayStation® Driver

You can set the PlayStation® Driver programme to optimise performance of PlayStation® format software.

### Hint

The settings will automatically return to the default settings in the following case:

- When the console is turned off

## Disc Speed

<u>Standard</u>	Loads discs at normal speed
Fast	Loads discs at high speed

### Hint

Set to "Standard" in the following cases:

- When fast loading does not produce improved results
- When using a software that is not compatible with fast loading

## Texture Mapping

<u>Standard</u>	Displays as normal
Smooth	Displays with reduced roughness in on-screen images

### Hint

Set to "Standard" in the following cases:

- When smooth texture mapping does not produce improved results
- If the picture does not display properly when set to "Smooth"

## DVD Player

If you set "Progressive" to "On" when the console is connected to a TV without the necessary equipment, the picture quality may be reduced or the picture may not be displayed. You can clear the "Progressive" setting by following the procedure below.

Remove the DVD before clearing the setting.

## Clear Progressive Setting

<u>No</u>	Leaves the "Progressive" setting on
Yes	Clears the "Progressive" setting

- 1 Display the Version Information screen.**
- 2 Using the directional buttons, select "DVD Player" and then press the  $\triangle$  button.**  
The "Clear Progressive Setting" option is displayed.
- 3 Press the  $\times$  button.**
- 4 Select "Yes", and then press the  $\times$  button.**
- 5 Press the  $\odot$  button twice.**  
The display returns to the main menu.
- 6 Press the  $\triangle$  (open) button on the console front, and place a DVD in the console.**

## **7 Close the disc cover.**

Playback begins.

### **Hint**

The setting will not be cleared if 1) you do not start a DVD after step 4 or 2) you reset or turn off the console before step 6.

## Connecting to a network

You can enjoy online games by connecting the PlayStation®2 console to a broadband network. To play all online games, you will need the following:

- A network compatible PlayStation®2 game
- Broadband Internet service
- A commercially available Ethernet cable
- A memory card (8MB) (for PlayStation®2) (sold separately)

### Hints

- You cannot play online games with this console using a dial-up or ISDN connection.
- USB connectivity from the External Network Device to the USB connector is not supported.
- There are two types of Ethernet cables: straight-through cable and crossover cable. Ensure that you use the correct type of cable when connecting your PlayStation®2 console to your Broadband Internet connection. Refer to the Instruction Manual supplied with the network device, or your Broadband Internet Service Provider for details.

## Connecting with an Ethernet cable

You can connect the console to a network using an Ethernet cable connected to the NETWORK connector on the console rear. You can connect to a 100 Base-TX or 10 Base-T network. Refer to the instructions supplied with the network device for details.

### Basic network setup

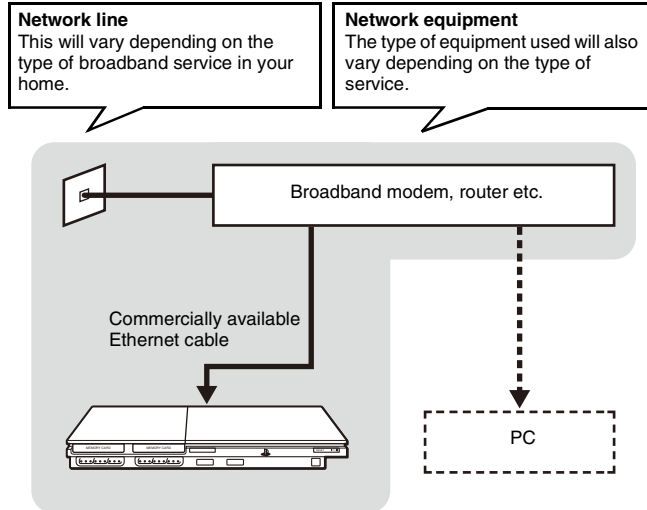

### Hint

When connecting the console and a PC to the network, a network device such as a router or a hub may be required. Refer to the instructions supplied with the network device for details.

For more information on network setup, visit [www.playstation.com](http://www.playstation.com)

## Connecting the console

### Warning

Do not plug the AC power cord for the console into the electrical outlet until you have made all other connections.

## 1 Connect the Ethernet cable to the NETWORK connector on the console rear.

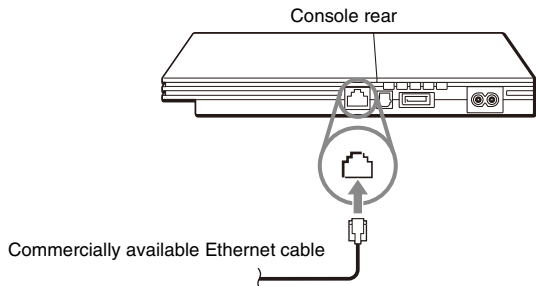

## 2 Connect the Ethernet cable to the network device.

The connection method will vary depending on the network device. Refer to the instructions supplied with the network device for details.

### Warning

Do not connect Ethernet cables or telephone cords of the following types to the network connector; too much electrical current may pass through the connector, causing a malfunction, excessive heat or fire in the connector:

- Standard residential telephone lines
- Ethernet cables not appropriate for use with a 10Base-T/100Base-TX network
- Any ISDN (digital) compatible phone or data line
- PBX phone lines
- Other "unknown" types of telephone lines

# Creating network settings

After you have connected an Ethernet cable to the console, you will need to create and save network settings. To do this you need a Network Access Disc supplied by registering your PlayStation®2 console. You can register your PlayStation®2 console by visiting [www.ps2registration.com](http://www.ps2registration.com)

## Items you will need

To create a network setting, you will need the following items:

- A Memory Card (8MB) (for PlayStation®2) (sold separately)
- Login and network setup information provided by your Broadband Internet Service Provider

### Hint

Depending on the type of Internet service used, you may need to provide your Broadband Internet Service Provider with your MAC Address. You can find the MAC Address for your console listed in the Version Information screen (→▶ page 35).



# Specifications

Design and specifications are subject to change without notice.

## General

Power requirements	220-240 V AC, 50/60 Hz
Power consumption (approx.)	35 W
Console dimensions (approx.)	230 × 28 × 152 mm (w/h/d)
Console mass (approx.)	720 g
Signal format	PAL
Operating temperature	5 °C to 35° C
Inputs/outputs on the console front	Controller port (2) MEMORY CARD slot (2) USB connector (2)
Inputs/outputs on the console rear	NETWORK connector ~AC IN connector AV MULTI OUT connector DIGITAL OUT (OPTICAL) connector

## Supplied accessories

See the Quick Reference manual (→ page 2)

## About national export control

This product may fall within the scope of national export control legislation. You must comply fully with the requirements of such legislation and of all other applicable laws of any jurisdiction in relation to this product.

## About access control

This product incorporates access control technology. Use of software not specifically designed for this product (excluding DVD-Videos and audio CDs) and copies of software designed for this product are prevented by access control. Unauthorised transfer, delivery, display, export, import, or transmission of programs, devices, or the product modified with programs or devices, to defeat the purpose of this access control feature is or may be prohibited by law.

SONY



COMPUTER  
ENTERTAINMENT ©

[www.playstation.com](http://www.playstation.com)

---

"PS", "PlayStation", "PS2", "DUALSHOCK" and "△○×□" are registered trademarks of Sony Computer Entertainment Inc.  
"SONY" and "PS" are registered trademarks and "MagicGate" is a trademark of Sony Corporation.

---